

## 90 DAY LIMITED WARRANTY

Winegard Company warrants this Winegard product against any defects in materials or workmanship within 90 (ninety) days from date of purchase. No warranty claim will be honored unless at the time the claim is made, you present proof of purchase to an authorized Winegard dealer (if unknown, please contact Winegard Company, 3000 Kirkwood Street, Burlington, IA 52601-2000, Telephone 319-754-0600).

Winegard Company (at its option) will either repair or replace the defective product at no charge to you. This warranty covers parts, but does not cover any costs incurred in removal, shipping or reinstallation of the product. This limited warranty does not apply if the product is damaged, deteriorates, malfunctions or fails from: misuse, improper installation, abuse, neglect, accident, tampering, modification of the product as originally manufactured by Winegard, usage not in accordance with product instructions or acts of nature such as damage caused by wind, lightning, ice or corrosive environments such as salt spray and acid rain.

The 90 Day Warranty is provided on the condition that the equipment is properly delivered with all handling and freight charges prepaid to your Winegard dealer for return to our factory for repair or replacement. Winegard dealers will arrange for the replacement or repair and return to you without charge the product which failed due to defective material or workmanship.

WINEGARD COMPANY WILL NOT ASSUME ANY LIABILITIES FOR ANY OTHER WARRANTIES, EXPRESS OR IMPLIED, MADE BY ANY OTHER PERSON.

ALL OTHER WARRANTIES WHETHER EXPRESS, IMPLIED OR STATUTORY INCLUDING WARRANTIES OF FITNESS FOR A PARTICULAR PURPOSE AND MERCHANTABILITY ARE LIMITED TO THE 90-DAY PERIOD OF THIS WARRANTY.

The foregoing shall be the sole and exclusive remedy of any person, whether in contract, tort or otherwise, and Winegard shall not be liable for incidental or consequential damage or commercial loss, or from any other loss or damage except as set forth above.

Some states do not allow limitations on how long an implied warranty lasts, or the exclusion of limitation of incidental or consequential damages, so the above limitations or exclusions may not apply to you.

This warranty gives you specific legal rights and you may also have other rights which vary from state to state.



Winegard Company • 3000 Kirkwood St.  
Burlington, IA 52601-2000  
319/754-0600 • Fax 319/754-0787  
www.winegard.com 2452031 Rev. 2/04

Printed in U.S.A. © 2003,2004 Winegard Company

# WINEGARD®

## SquareShooter™ HDTV<sup>2</sup>

### Model SS-1000 DIRECTIONAL ANTENNA

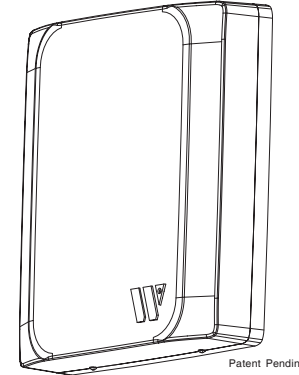

The **SquareShooter™ HDTV<sup>2</sup>** directional antenna by Winegard is designed for high definition (high resolution) digital TV. HDTV (High Definition TV) has 10 times more picture detail than analog signals! And the **SquareShooter™ HDTV<sup>2</sup>** receives these HDTV signals at greater distances! For example — Analog range is 40-50 miles; Digital range is 50-60 miles.

With HDTV, advantages include more detailed pictures, high quality sound, plus there's no "snow" or weak signal area with this technology. You receive a *perfect* picture on your TV, or no picture at all.

The **SquareShooter™ HDTV<sup>2</sup>** has exceptional reception characteristics for High-band VHF and UHF channels 7 – 69. It is tunable for increased Low-band VHF performance by rotating the antenna from the horizontal plane to the vertical plane (rotation bracket included). This makes the antenna more resonate in the Low-band VHF channels 2 – 6 with excellent reception characteristics in the 15 – 20 mile range. This rotation of the antenna element may also assist in mitigating any co-channel interference issues (meter recommended for this application).

## WARNING

Installation of this antenna near power lines is dangerous. For your safety, follow these installation instructions!

Winegard Company • 3000 Kirkwood St. • Burlington, IA 52601-2000 • 319/754-0600  
Fax 319/754-0787 • www.winegard.com 2452031 Rev. 2/04

**EXAMPLE OF ANTENNA  
GROUNDING IN  
ACCORDANCE WITH THE  
NATIONAL ELECTRICAL CODE  
INSTRUCTIONS**

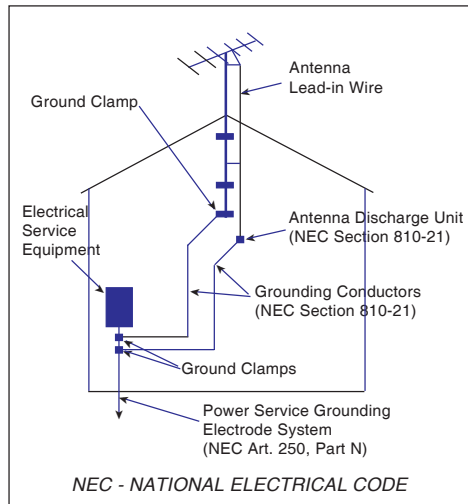

15. Do not overload wall outlets and extension cords as this can result in a risk of fire or electric shock.

16. Never push objects of any kind into this video product through openings as they may touch dangerous voltage points or short-out parts that could result in a fire or electric shock. Never spill liquid of any kind on the video product.

17. Do not attempt to service this video product yourself as opening or removing covers may expose you to dangerous voltage or other hazards. Refer all servicing to qualified service personnel.

18. Unplug this video product from the wall outlet and refer servicing to qualified service personnel under the following conditions:

a. When the power supply cord or plug is damaged.  
b. If liquid has been spilled or objects have fallen into the video product.

c. If the video product, except for antenna mounted preamplifiers and downconverters, has been exposed to rain or water.

d. If the video product does not operate normally by following the operating instructions. Adjust only those controls, when provided, that are covered by the operating instructions. An improper adjustment of other controls may result in damage that will often require extensive work by a qualified technician to restore the video product to its normal operation.

e. If the video product has been dropped or the housing has been damaged.

f. When the video product exhibits a distinct change in performance - this indicates a need for service.

19. When replacement parts are required, be sure the service technician has used replacement parts specified by the manufacturer or have the same characteristics as the original part. Improper substitutions may result in fire, electric shock or other hazards.

20. Upon completion of any service or repairs to this video product, ask the service technician to perform safety checks to determine that the video product is in proper operating condition.

21. Note to CATV system installer: This reminder is provided to call the CATV system installer's attention to Art. 820-40 of the NEC that provides guidelines for proper grounding and, in particular, specifies that the cable ground shall be connected to the grounding system of the building, as close to the point of cable entry as possible.

22. This product should be mounted to a wall or ceiling only as recommended by the manufacturer.

23. The product should be situated away from heat sources such as radiators, heat registers, stoves or other products (including amplifiers) that produce heat.

## Adjusting your Square Shooter for best reception

For the best reception, we suggest you have someone watching the TV while you adjust the antenna.

**NOTE:** See **Figure 4** for bolt locations covered in the following steps.

**STEP 1.** To adjust **rotation**, loosen the 2 bolts on the pipe clamp and rotate the pipe. Rotation can be up to 90°.

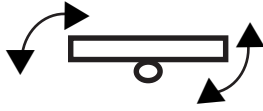

**Step 2.** To adjust the **elevation angle**, loosen the bolt and nut at the bottom of the curved slot. Adjust the angle of the antenna.



**STEP 3.** To adjust the **tilt**, loosen the 4 bolts holding the elevation bracket. Now tilt the antenna for the best picture.

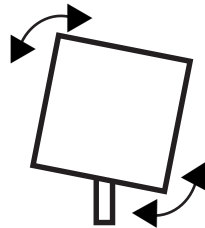

**Figure 4**

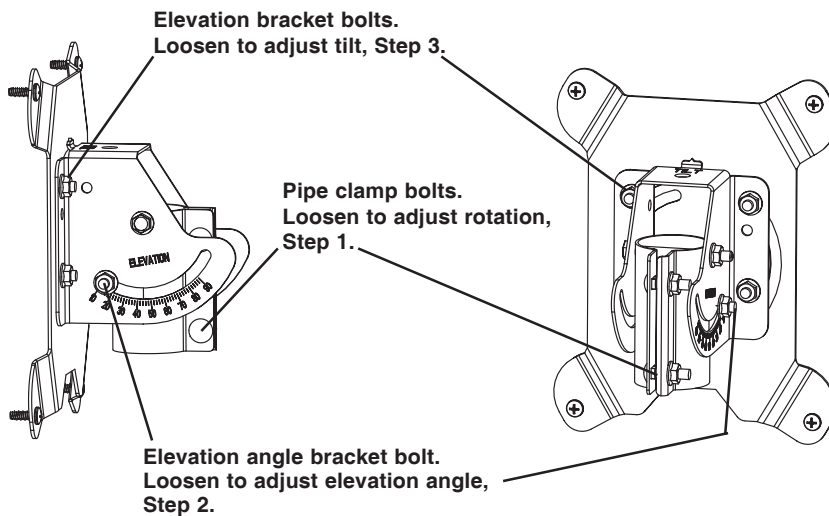

## IMPORTANT SAFEGUARDS

**WARNING: TO REDUCE RISK OF FIRE OR ELECTRICAL SHOCK, DO NOT EXPOSE TO RAIN OR MOISTURE.**  
(Not applicable to mount and antenna)

**CAUTION!**  
**RISK OF**  
**ELECTRIC SHOCK.**  
**DO NOT OPEN!**



**Dangerous voltage**  
**inside enclosure**



**Refer to operating, maintenance and safeguard literature accompanying unit.**

**CAUTION: TO REDUCE RISK OF ELECTRICAL SHOCK, DO NOT REMOVE COVER, NO USER-SERVICEABLE PARTS INSIDE. REFER SERVICING TO QUALIFIED PERSONNEL**

- All the safety and operating instructions should be read before the appliance is operated.
- The safety and operating instructions should be retained for future reference.
- All warnings on the appliance and in the operating instructions should be adhered to.
- All operating and use instructions should be followed.
- Unplug this video or audio product from the wall outlet before cleaning. Do not use liquid cleaners or aerosol cleaners. Use a damp cloth for cleaning.
- Do not use attachments not recommended by the video product manufacturer as they may cause hazards.
- Do not use this video product near water - for example, near a bath tub, wash bowl, kitchen sink, or laundry tub, in a wet basement, or near a swimming pool, and the like.
- If slots, holes and openings are located in the housing, they are provided for ventilation and to ensure reliable operation of the video product and to protect it from overheating. These openings should never be covered. The openings should never be blocked by placing the video product on a bed, sofa, rug, or other similar surface. This video product should never be placed near or over a radiator or heat register. This video product should not be placed in a built-in installation such as a bookcase or rack unless proper ventilation is provided or the manufacturer's instructions have been adhered to.
- This video product should be operated only from the type of power source indicated in electrical rating printed on the appliance or power supply.

10A. If the appliance is equipped with a polarized alternating-current line plug (a plug having one blade wider than the other) this plug will fit into the power outlet only one way. This is a safety feature. If you are unable to insert the plug fully into the outlet, try reversing the plug. If the plug should still fail to fit, contact an electrician to replace your obsolete outlet. Do not defeat the safety purpose of the polarized plug.

10B. If the appliance is equipped with a 3-wire grounding-type plug, a plug having a third (grounding) pin, this plug will only fit into a grounding-type power outlet. This is a safety feature. If you are unable to insert the plug into the outlet, contact an electrician to replace your obsolete outlet. Do not defeat the purpose of the grounding-type plug.

11. Power-supply cord should be routed so that it is not likely to be walked on or pinched by items placed upon or against it, paying particular attention to cord at plug, convenience receptacle and the point where cord exits from the appliance.

12. If an outside antenna or cable system is connected to this video product, be sure system is grounded so as to provide some protection against voltage surges and built-up static charges. Proper method is shown at the top of the next page.

13. An outside antenna system should not be located in the vicinity of overhead power lines or other electric light or power circuits, or where it can fall into such power lines or circuits. When installing an outside antenna system, extreme care should be taken to keep from touching such power lines or circuits as contact with them might be fatal.

14. For added protection for this video product during a lightning storm, or when it is left unattended and unused for long periods of time, unplug it from the wall outlet and disconnect the antenna or cable system.

## Mounting Options

Before assembly, determine the best location for HDTV signal reception. Point antenna toward station transmitter. To find exact location, go to [www.antennaweb.org](http://www.antennaweb.org). Mount options are:

- Exterior wall mount (for masonry walls, you must provide anchors)
- Roof mount
- Attic mount
- Rail/deck mount

Another mount option is Winegard's DS-1000 combination mount for satellite dish and SS-1000. This mount, with SS-1000 and satellite dish, will meet wind specs.

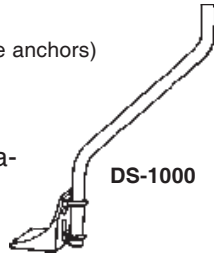

### SS-1000 includes:

Assembled Antenna	Assembled mount pipe and foot
4 #12 x 5/8" plastite screws (attach mt. bracket to antenna)	2 U-Bolts and hex nuts 4 lag bolts

Figure 1

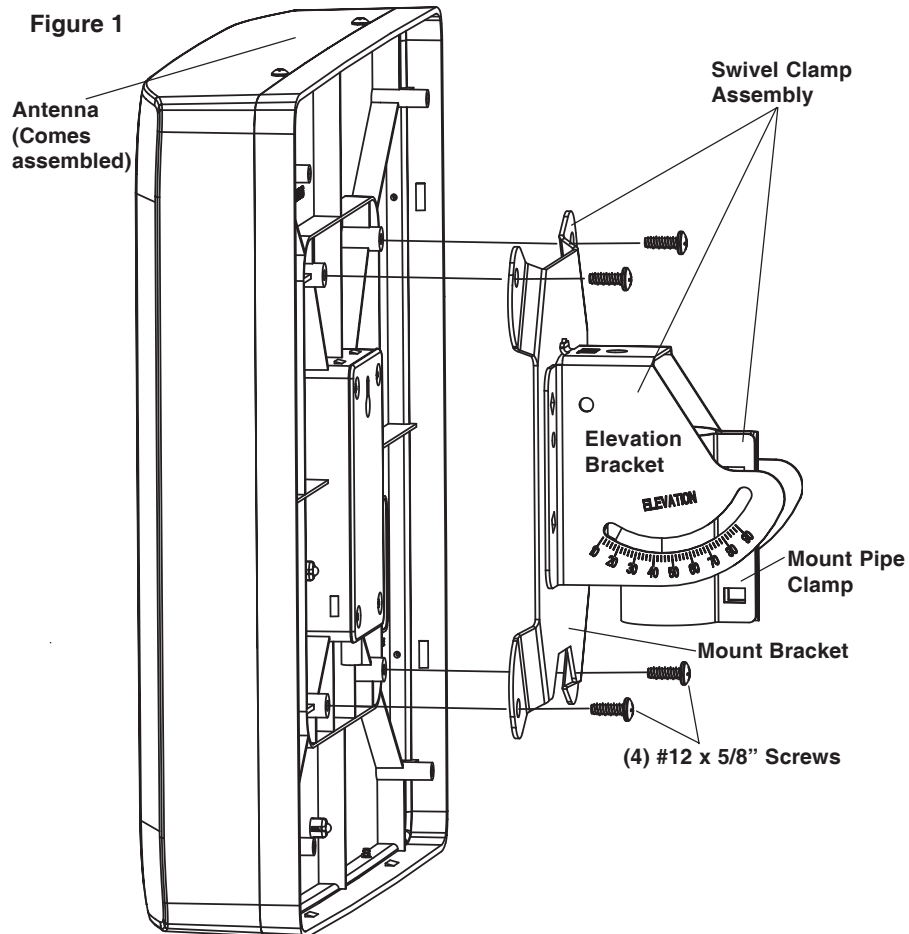

## Assembly

**STEP 1.** Connect coax cable\* (not provided) to coax connection on back of antenna. **\*Use RG-6/U coax cable.**

**STEP 2.** Attach pipe and foot at the location selected for the antenna.

If you are mounting on a masonry surface, you must provide your own masonry anchors.

If you are mounting on a railing, for example, two U-bolts are provided for rails, pipes, etc. up to 2" in diameter.

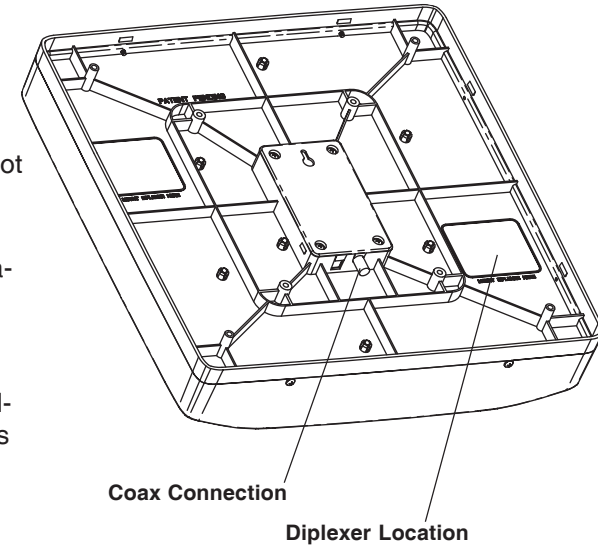

Figure 2

**STEP 3.** Attach swivel bracket assembly to back of antenna, using screws provided (4 #12 x 5/8). Do not overtighten.

**STEP 4.** Mount antenna on pipe/foot assembly attached to selected location surface.

**STEP 5.** Attach coax cable to mount pipe with weatherproof tape or cable ties.

Connect coax cable from antenna to your HDTV signal or analog signal input. The connection depends on your TV reception system setup; check your component manuals.

**NOTE:** If using diplexer, connect coax to diplexer secured on back of antenna with velcro (supplied).

Figure 3 Antenna and Mount Assembled

